

PART/PRINT NO.
GL-24FSC-32

PART DESCRIPTION
ROUND SOLID FIBERGLASS COVER W/ LIP

DATE
06/16/16

THIS DRAWING IS THE SOLE PROPERTY OF AK INDUSTRIES INC.

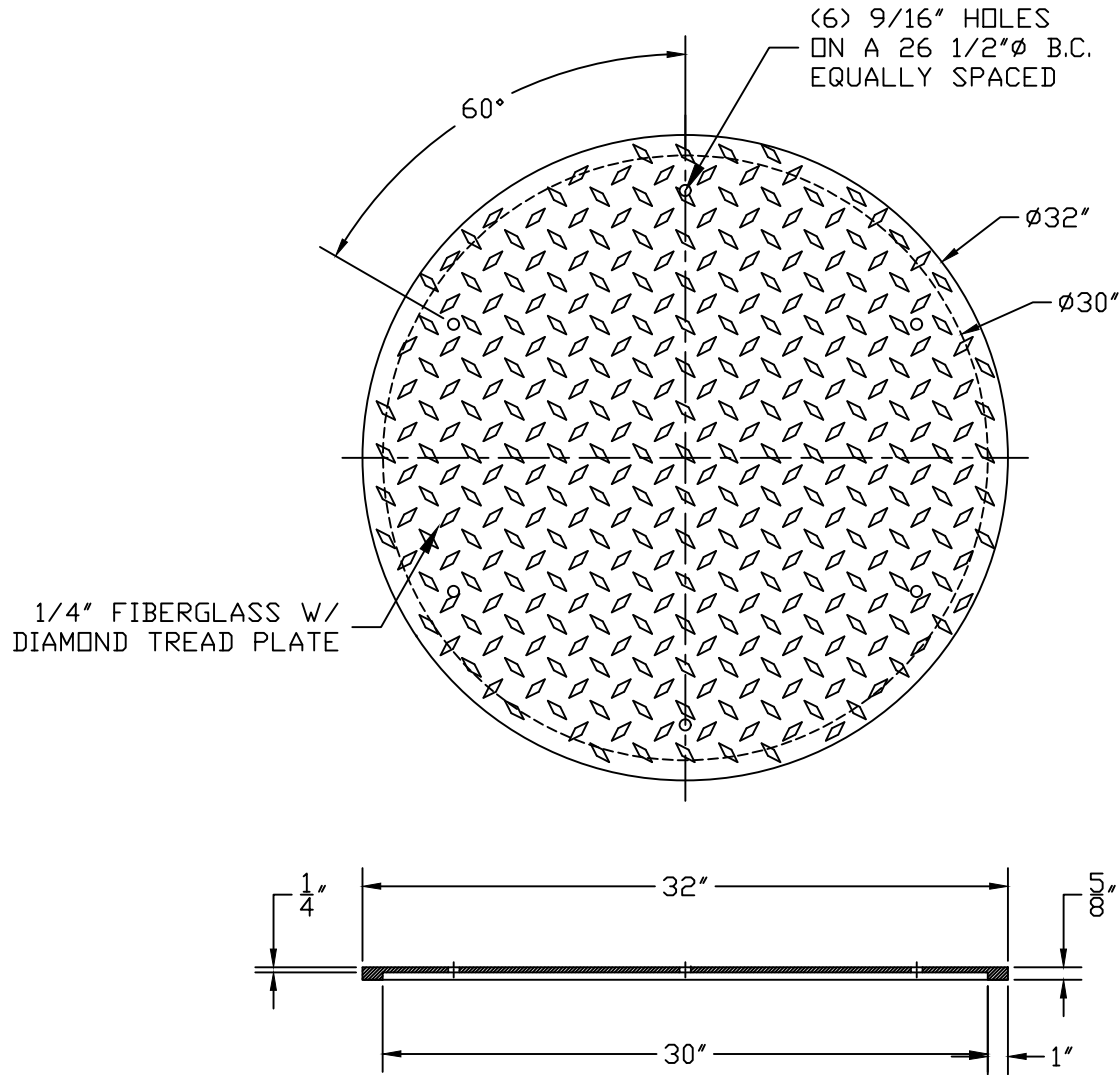

AK INDUSTRIES INC.
2055 PIDCO DR.
PLYMOUTH, IN. 46563
PHONE: (574) 936-6022

DRAWN BY:
A.HARTUNG

SCALE:
NOT TO SCALE

REVISION #:

SIGNATURE: