

PART/PRINT #:

PART DESCRIPTION:

SCALE:

REVISION:

DATE:

AKP20010

BASIN RIB 24X48

NOT TO SCALE

003

04/10/07

THIS DRAWING IS THE SOLE PROPERTY OF AK INDUSTRIES INC.

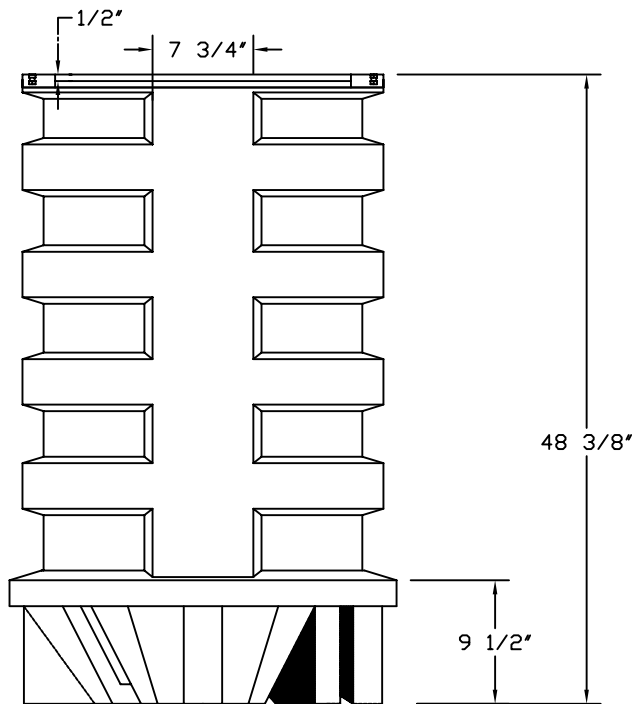
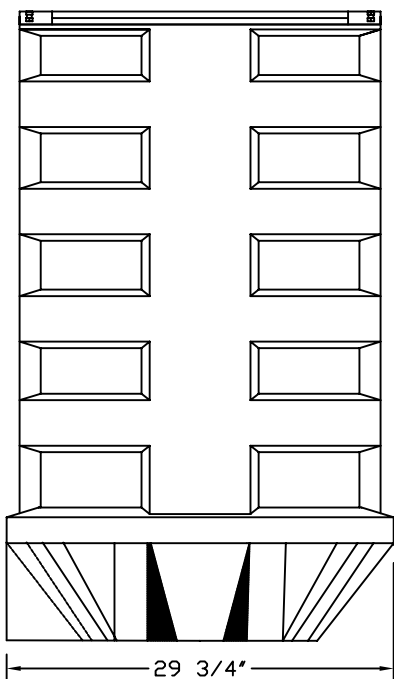
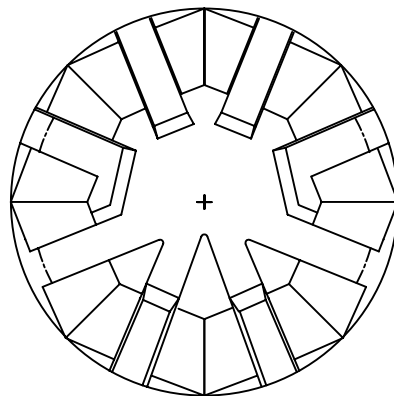
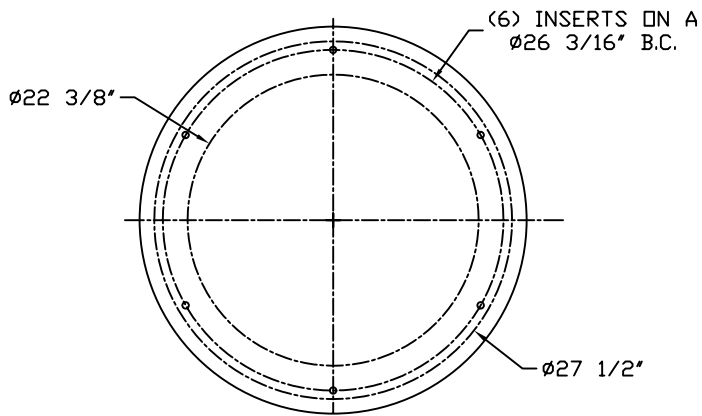

B.O.M

AKR50070 (6) 1/4-20 ALUMINUM INSERTS

NOTE:

USE NEW TOP AND NEW BOTTOM



AK INDUSTRIES INC.  
 2055 PIDCO DR.  
 PLYMOUTH, IN. 46563  
 PHONE: (574) 936-6022

DRAWN BY:  
 M. OLIVAREZ

TOLERANCE:  
 $\pm 0.250$  UNLESS SPECIFIED OTHERWISE

SIGNATURE: