

PART/PRINT #:

PART DESCRIPTION:

DATE:

GB-72-301

72"Ø FIBERGLASS BASIN W/ SQUARE ANTI-FLOATATION COLLAR & STEEL INSERT

05/25/16

THIS DRAWING IS THE SOLE PROPERTY OF AK INDUSTRIES INC.

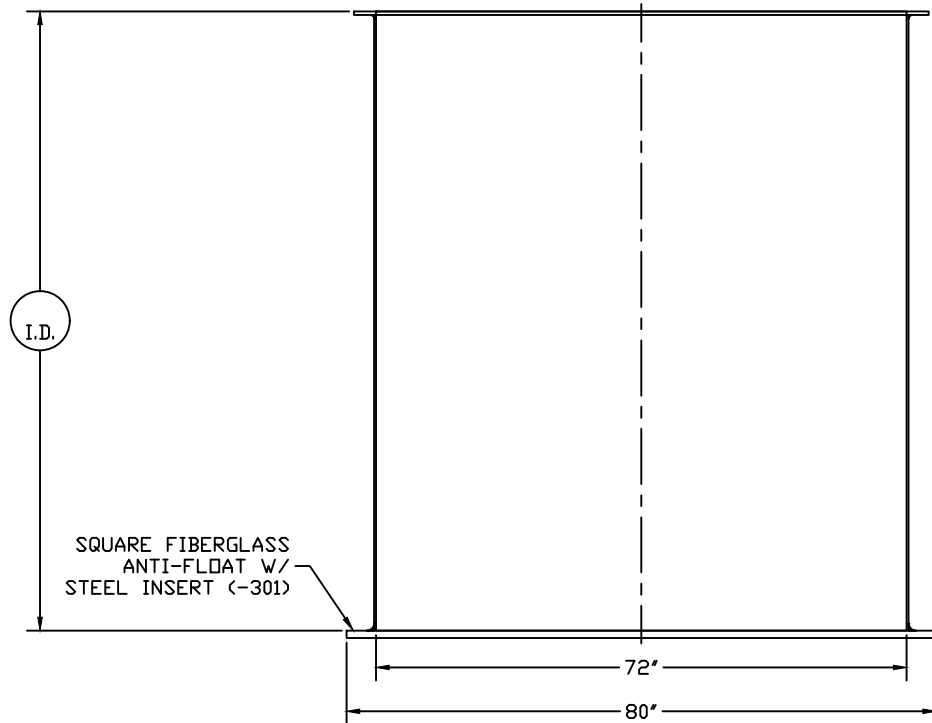
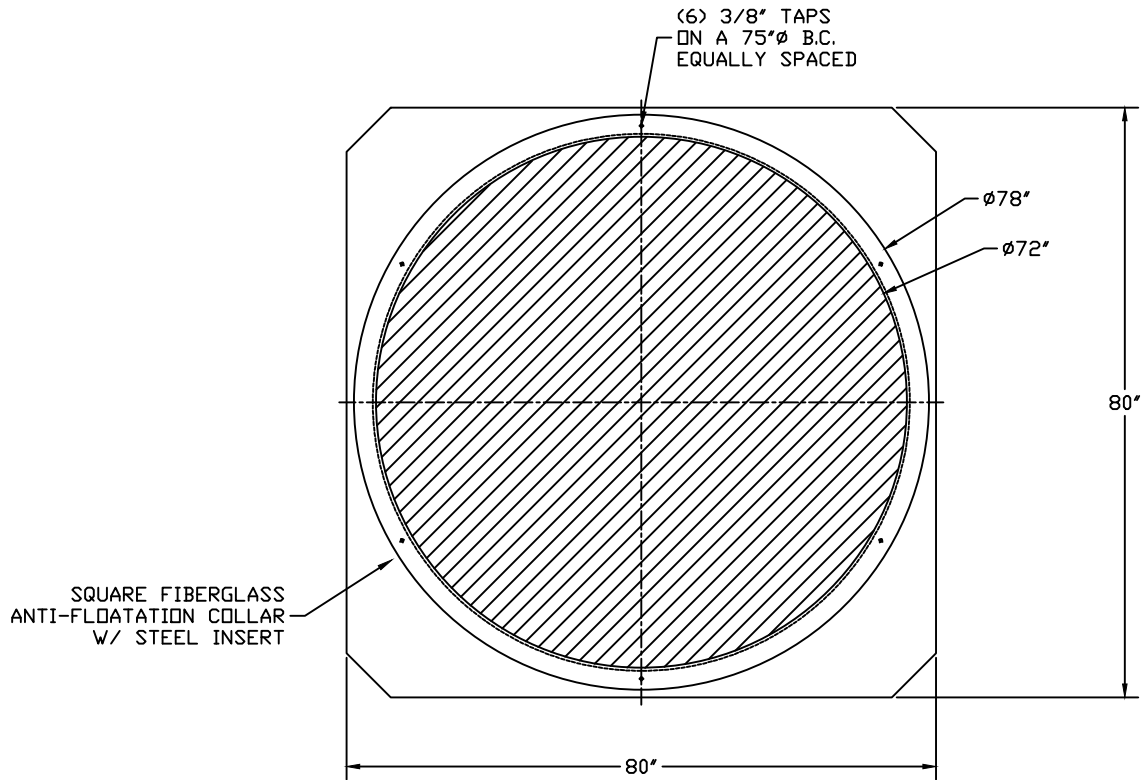

AK INDUSTRIES INC.
2055 PIDCO DR.
PLYMOUTH, IN. 46563
PHONE:(574) 936-6022

DRAWN BY:
A.HARTUNG
J.CONLEY

SCALE:
NOT TO SCALE

REVISION#:

SIGNATURE: