

PART/PRINT NO.
LA-RP1

PART DESCRIPTION
RP1 (CORD SEAL) 2 HOLE

REVISION
001

DATE
2/26/03

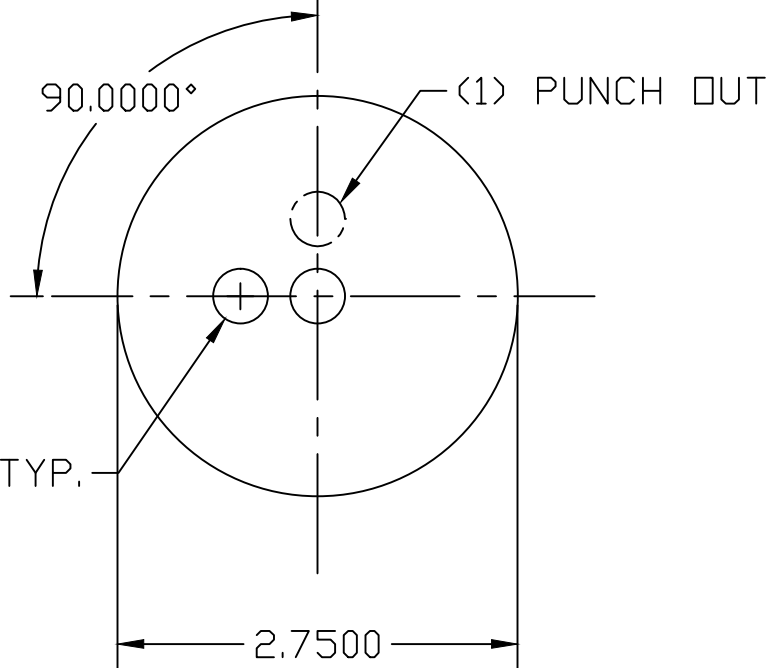
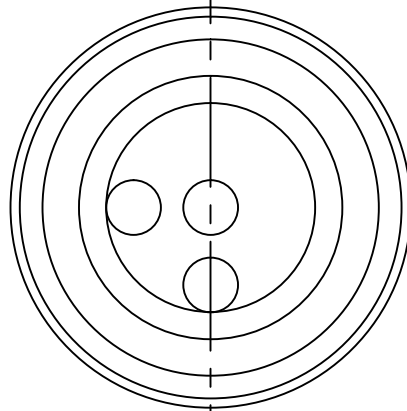
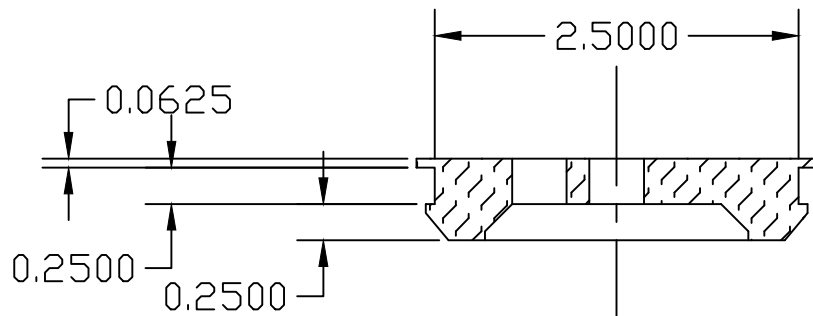

DRAWN
M.OLIVAREZ

MATERIAL

TOLERANCE
+/- .025 UNLESS SPECIFIED OTHERWISE

SIGNATURE