

PART/PRINT NO.
AKP90010

PART DESCRIPTION
30" ROUND FIBERGLASS SOLID COVER

REVISION
000

DATE
8/12/09

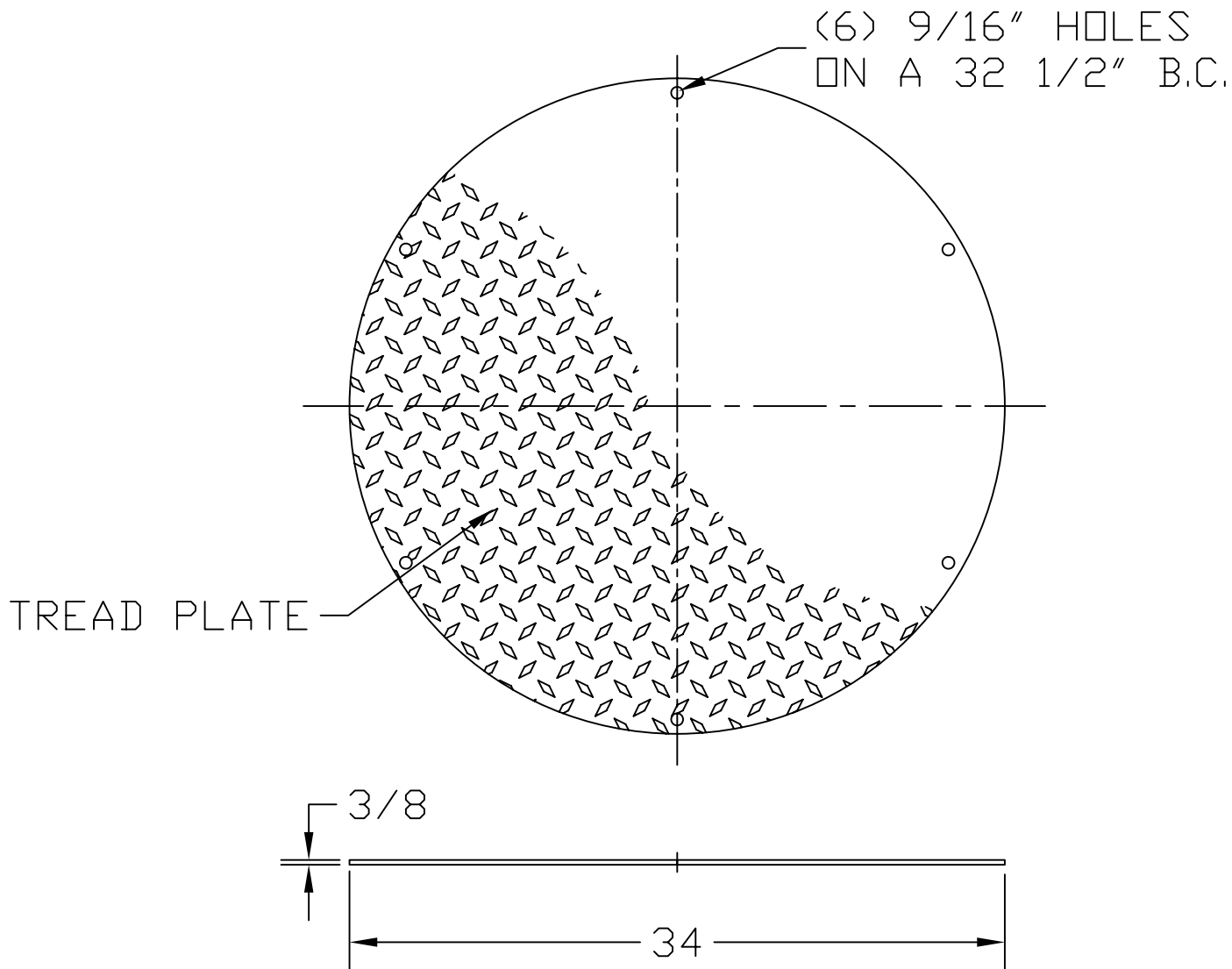

NOTE:
1. LIDS MAY BE CONVEX NO MORE THAN .250
2. LIDS CANNOT BE CONCAVE

B.O.M
AKR20123 34 RTM TREAD COVER
AKP90015 30" RTM GLASS COVER GASKET PACK

DRAWN
M.Olivarez

MATERIAL
FIBERGLASS

TOLERANCE
+/- .125 UNLESS SPECIFIED OTHERWISE

SIGNATURE